



Canon

P17-D

English →

Deutsch →

Français →

Español →

Italiano →

Instructions

Bedienungsanleitung

Notice d'emploi

Instrucciones

Istruzioni

CONTENTS

1. Keys and Controls	1
2. How to Replace the Ink Roller	8
3. How to Insert Printing Paper	9
4. How to Load and Replace Dry Batteries	10
5. Canon AC Adapter AD-4II (Optional)	12
6. The NiCd Battery (Optional)	13
7. Overflow Interlock Function	15
8. Calculation Examples	17

INHALT

1. Tasten und Funktionselemente	1
2. Auswechseln der Farbrolle	8
3. Einlegen einer neuen Papierrolle	9
4. Einlegen und Auswechseln der Trockenbatterien	10
5. Canon-Wechselstrom-Adapter AD-4II (Sonderzubehör)	12
6. Der NiCd-Akkus (Sonderzubehör)	13
7. Funktion der Überlaufsperrung	15
8. Rechenbeispiele	17

TABLE DES MATIERES

1. Organisation du clavier	1
2. Remplacement du rouleau encreur	8
3. Mise en place du papier d'impression	9
4. Mise en place et remplacement des piles	10
5. Adaptateur c.a. Canon AD-4II (En option)	12
6. La batterie au NiCd (En option)	13
7. Dépassement de capacité	15
8. Exemples de calculs	17

INDICE

1. Teclas y conmutadores	1
2. Reemplazo del rodillo entintador	8
3. Colocación del papel de imprimir	9
4. Carga y reemplazo de las pilas	10
5. Adaptador CA AD-4II Canon (Opcional)	12
6. La pila NiCd (Opcional)	13
7. Función de Inmovilización por capacidad excedida	15
8. Ejemplos de cálculos	17

INDICE

1. Tasti e comandi	1
2. Sostituzione rullo dell'inchiostro	8
3. Come inserire la carta da stampa	9
4. Sostituzione delle batterie	10
5. Adattatore per CA AD-4II Canon (Opzionale)	12
6. La Batteria al NiCd (Opzionale)	13
7. Blocco a causa di eccedenza	15
8. Esempi di calcolo	17

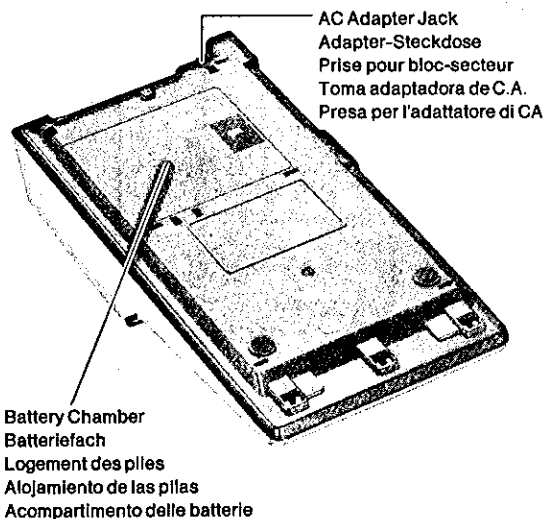
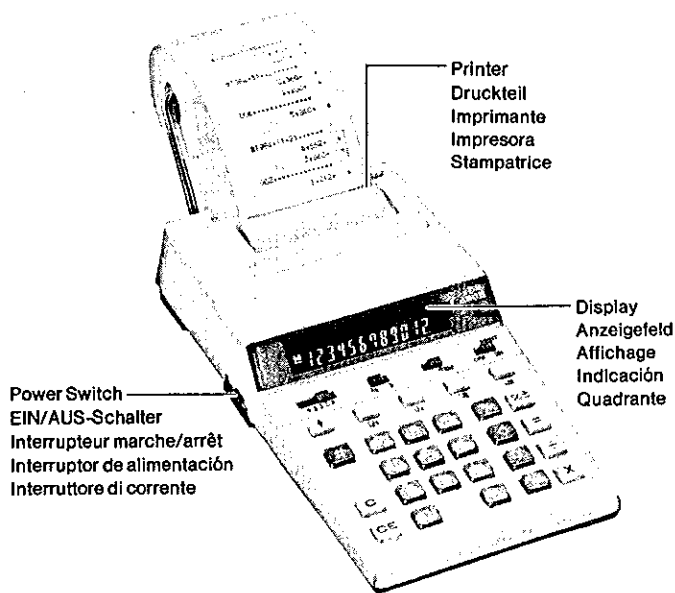

1. Keys and Controls

0 ~ 9 Numeric Keys

Decimal Point Key For entering numbers

Example: 123 → **1 2 3**
4500 → **4 5 0 0**
45.6 → **4 5 . 6**
0.789 → **. 7 8 9**

+ - Addition and Subtraction Keys

Subtotal Key: For obtaining intermediate results of addition and subtraction.

Total Key: For obtaining results of addition and subtraction.
Addition and Subtraction Example

$2 - 3 + 4 = 3$ Operation
2 + 3 - 4 + * (3)

x ÷ Multiplication and Division Keys

Equal Key: For obtaining results of multiplication and division.

Multiplication and Division Example
 $2 \times 3 + 4 = 1.5$ Operation
2 x 3 + 4 = (1.50)

1. Tasten und Funktionselemente

0 ~ 9 Zehnergastatur Für die Eingabe von Zahlenwerten

Beispiele: 123 → **1 2 3**
4500 → **4 5 0 0**
45.6 → **4 5 . 6**
0.789 → **. 7 8 9**

+ - Additions- und Subtraktionstasten

Zwischensummentaste: Zur Ermittlung von Zwischenergebnissen der Addition und Subtraktion.

Endergebnistaste: Zur Ermittlung von Ergebnissen der Addition und Subtraktion.

Addition und Subtraktion Beispiel
 $2 - 3 + 4 = 3$ Ausführung
2 + 3 - 4 + * (3)

x ÷ Multiplikations- und Divisionstasten.

Ergebnistaste: Zur Ermittlung von Ergebnissen der Multiplikation und Division.

Multiplication and Division Beispiel
 $2 \times 3 + 4 = 1.5$ Ausführung
2 x 3 + 4 = (1.50)

1. Organisation du clavier

0 ~ 9 Touches numériques Pour l'entrée des données numériques

Point décimal (virgule) numérique
Exemple: 123 → **1 2 3**
4500 → **4 5 0 0**
45.6 → **4 5 . 6**
0.789 → **. 7 8 9**

+ - Addition et soustraction

Total partiel: Permet d'obtenir des résultats intermédiaires lors d'additions ou de soustractions successives.

Total: Permet d'obtenir les résultats d'additions et de soustractions.

Exemple d'addition et de soustraction
 $2 - 3 + 4 = 3$ Exécution
2 + 3 - 4 + * (3)

x ÷ Multiplication et division

Egale: Permet d'obtenir les résultats de multiplications et de divisions.

Exemple de multiplication et de division
 $2 \times 3 + 4 = 1.5$ Exécution
2 x 3 + 4 = (1.50)

1. Teclas y conmutadores

0 ~ 9 Teclas numéricas Para entrar números

Tecla de coma decimal
Ejemplos: 123 → **1 2 3**
4500 → **4 5 0 0**
45.6 → **4 5 . 6**
0.789 → **. 7 8 9**

+ - Teclas de suma y resta

Tecla de subtotales: Para obtener resultados intermedios de sumas y restas.

Tecla de resultados totales: Para obtener resultados de sumas y restas.

Ejemplo de suma y resta
 $2 - 3 + 4 = 3$ Operación
2 + 3 - 4 + * (3)

x ÷ Teclas de multiplicación y división.

Tecla de igual: Para obtener resultados de multiplicaciones y divisiones.

Ejemplo de multiplicación y división
 $2 \times 3 + 4 = 1.5$ Operación
2 x 3 + 4 = (1.50)

1. Tasti e comandi

0 ~ 9 Tasti numerici Per l'impostazione dei numeri

Tasto del punto decimale
Esempi: 123 → **1 2 3**
4500 → **4 5 0 0**
45.6 → **4 5 . 6**
0.789 → **. 7 8 9**

+ - Tasti di addizione e sottrazione

Tasto del totale parziale: Per ottenere i risultati parziali di addizioni e sottrazioni.







Tasto del totale: Per ottenere i risultati di addizioni e sottrazioni.

Esempio di addizione e sottrazione
 $2 - 3 + 4 = 3$ Operazione
2 + 3 - 4 + * (3)

x ÷ Tasti di moltiplicazione e divisione.

Tasto dell'uguale: Per ottenere i risultati di moltiplicazioni e divisioni.

Esempio di moltiplicazione e divisione
 $2 \times 3 + 4 = 1.5$ Operazione
2 x 3 + 4 = (1.50)







-  **Clear Key:** For clearing all registered calculations except memory.
-  **Clear Entry Key:** For correcting incorrect entries.
Example: $123 \times 456 = 56088$
 123  756  456  (56088.)
-  **Percent Plus/Minus Key:** For performing percentage add-on and discount calculations.
-  **Non-Add Key:** For printing figures not affecting calculation such as serial numbers or data.

M+

Memory Plus/Equal Key: For obtaining the results of multiplication and division and adding them automatically to the memory. This key is also used to add a number to the memory.

M-

Memory Minus/Equal Key: For obtaining the results of multiplication and division and subtracting them automatically from the memory. This key is also used to subtract a number from the memory.







-  **Taste für Löschung der Rechenregister:** Zur Löschung aller Rechenregister außer dem Speicher.
-  **Einzellösch taste:** Zum Korrigieren eines falsch eingetasteten Wertes.
Beispiel: $123 \times 456 = 56088$
 123  756  456  (56088.)
-  **Prozenttaste:** Zur Berechnung von prozentualen Auf- und Abschlägen.
-  **Nichtrechentaste:** Zum Ausdrucken von Zahlen, die den Rechenablauf nicht beeinflussen, wie z.B. Seriennummern oder Daten.

M+

Taste für positive Eingabe in den Speicher: Zur Ermittlung eines Multiplikations- oder Divisionsergebnisses und automatischen Addition des Ergebnisses zum Speicherinhalt. Diese Taste wird auch benutzt, um einen Wert zum Speicherwert zu addieren.

M-

Taste für negative Eingabe in den Speicher: Zur Ermittlung eines Multiplikations- oder Divisionsergebnisses und automatischen Subtraktion des Ergebnisses vom Speicherinhalt. Diese Taste wird auch benutzt, um einen Wert vom Speicherwert zu subtrahieren.







-  **Effacement:** Cette touche efface tous les registres de calcul, à l'exception de la mémoire.
-  **Effacement d'affichage:** Permet de corriger une entrée erronée.
Exemple: $123 \times 456 = 56088$
 123  756  456  (56088.)
-  **Pourcentage plus-moins:** Permet d'obtenir le montant correspondant à un pourcentage qui peut être ensuite repris en majoration ou au rabais.
-  **Référence:** Permet d'imprimer des numéros de référence ou des dates sans pour autant perturber les calculs.

M+

Mémoire plus égale: Permet d'obtenir le résultat d'une multiplication ou division et de l'additionner par ailleurs au contenu de la mémoire. Permet également d'additionner une entrée au contenu de la mémoire.

M-

Mémoire moins égale: Permet d'obtenir le résultat d'une multiplication ou division et de le soustraire par ailleurs du contenu de la mémoire. Permet également de soustraire une entrée du contenu de la mémoire.

-  **Tecla de borrado:** Para borrar todos los registros de los cálculos excepto la memoria.
-  **Tecla de borrado de entradas:** Para corregir una entrada incorrecta.
Ejemplo: $123 \times 456 = 56088$
 123  756  456  (56088.)
-  **Tecla de porcentaje a sumar o restar:** Para ejecutar cálculos con incrementos o descuentos porcentuales.
-  **Tecla de no suma:** Para imprimir cifras que no afecten los cálculos, tales como números de serie o fechas.

M+







Tecla más igual de memoria: Para obtener el resultado de una multiplicación o división sumándolo automáticamente a la memoria.

M-

Esta tecla también se utiliza para sumar numerates a la memoria.

M+

Tecla menos igual de memoria: Para obtener el resultado de una multiplicación o división restándolo automáticamente de la memoria. Esta tecla también se utiliza para restar numerales de la memoria.

-  **Tasto di azzeramento:** Per azzerare tutti i registri di calcolo ad eccezione della memoria.
-  **Tasto di azzeramento dei dati impostati:** Per correggere una impostazione sbagliata.
Esempio: $123 \times 456 = 56088$
 123  756  456  (56088.)
-  **Tasto della percentuale di maggiorazione e sconto:** Per effettuare i calcoli della percentuale di maggiorazione e sconto.
-  **Tasto di non-addizione:** Per stampare dati, quali numeri di serie e data, senza interferire sui calcoli.

M+

Tasto della memoria più eguale: Per ottenere il risultato di una moltiplicazione o divisione e addizionarlo automaticamente alla memoria. Questo tasto serve anche per addizionare un numero alla memoria.

M-

Tasto della memoria meno eguale: Per ottenere il risultato di un moltiplicazione o divisione e sottrarlo automaticamente dalla memoria. Questo tasto serve anche per sottrarre un numero dalla memoria.

 **Subtotal Recall Memory Key:** Used to recall the memory contents. The memory register is not cleared.



 **Total Recall Memory Key:** Used to recall the memory contents. At the same time the memory register is cleared.

 **Paper Feed Key:** Used to continuously advance the printing paper.





Decimal Point Selector Switch: For designating the decimal point position for results of multiplication and division and for entries in addition and subtraction.

Example: $123 \times 0.456 = 56.09$

Operation	Printout
  123 <input checked="" type="checkbox"/>	123• x
.456 <input type="checkbox"/>	0•456 =
	56•09 *

 **Speicher-Subtotal-Taste:** Sie drückt den Inhalt des Speichers aus. Das Speicherregister wird nicht gelöscht.



 **Speicher-Total-Taste:** Sie drückt den Inhalt des Speichers aus. Gleichzeitig wird das Speicherregister gelöscht.

 **Papiertransporttaste:** Wird für laufenden Vorschub des Papierstreifens verwendet.





Kommawähler: Zur Bestimmung der Anzahl der Kommastellen für Ergebnisse der Multiplikation und Division so wie für Eingaben bei Addition und Subtraktion.

Beispiel: $123 \times 0,456 = 56,09$

Ausführung	Ausdruck
  123 <input checked="" type="checkbox"/>	123• x
.456 <input type="checkbox"/>	0•456 =
	56•09 *

 **Rappel de mémoire en total partiel:** Permet de rappeler le contenu de la mémoire sans pour autant l'annuler.



 **Rappel de mémoire:** Permet de rappeler le contenu de la mémoire qui se trouve alors remise à zéro.

 **Touche d'avancement du papier:** Permet de faire avancer la bande de papier de manière continue.



Sélecteur de décimales: Permet de fixer la position de la virgule pour les résultats de multiplications ou de divisions ainsi que pour les entrées d'additions ou de soustractions.

Exemple: $123 \times 0,456 = 56,09$

Exécution	Impression
  123 <input checked="" type="checkbox"/>	123• x
.456 <input type="checkbox"/>	0•456 =
	56•09 *

 **Tecla de llamada de subtotaes de la memoria:** Utilizada para llamar el contenido de la memoria. No borra el contenido del registro de la memoria.



 **Tecla de llamada del total de la memoria:** Utilizada para llamar el contenido de la memoria. Al mismo tiempo borra el registro de la memoria.

 **Tecla de avance del papel:** Utilizada para avanzar en forma continua el papel de impresión.





Selector de la coma decimal: Permite seleccionar la posición de la coma decimal para resultados de multiplicaciones y divisiones y para las entradas de sumas y restas.

Ejemplo: $123 \times 0,456 = 56,09$

Operación	Impresión
  123 <input checked="" type="checkbox"/>	123• x
.456 <input type="checkbox"/>	0•456 =
	56•09 *

 **Tasto di richiamo del totale parziale della memoria:** Per richiamare il contenuto della memoria. Il suo uso non azzerà il registro della memoria.



 **Tasto di richiamo del totale della memoria:** Per richiamare il contenuto della memoria. Il suo uso azzerà il registro della memoria.

 **Tasto di avanzamento della carta:** Per fare avanzare la carta in modo continuo.



Selettore del punto decimale: Per preselezionare la posizione del punto decimale nei risultati delle moltiplicazioni e divisioni, e per le impostazioni delle addizioni e sottrazioni.

Esempio: $123 \times 0,456 = 56,09$

Operazioni sulla tastiera	Stampa
  123 <input checked="" type="checkbox"/>	123• x
.456 <input type="checkbox"/>	0•456 =
	56•09 *

F (Floating Decimal Point): All effective numbers up to 12 digits are printed or displayed.

+(Add-Mode): Addition and subtraction are performed with an automatic 2-digit decimal. The \square key need not be depressed for individual entries.

Printer Switch

If the printer switch is turned ON while the power is ON, a dotted line will be printed.



Round-Off Switch: For rounding a final result of multiplication or division to a preselected number of decimal digits.

Left position for round-off, and right position for round-down.

Example: $5 + 9 = 0.5555 \dots$

Round-off

 $5 \div 9 = (0.556)$

Round-down

 $5 \div 9 = (0.555)$

F (Fließkomma): Alle effektiven Zahlen bis 12 Stellen werden ausgedruckt oder angezeigt.

+(Addier-Schaltung): Addition und Subtraktion werden automatisch mit 2 Nachkommastellen ausgeführt.

Die Taste \square muß nicht gedrückt werden.

Druckwerkschalter

Wenn man den Drucker-Schalter betätigt, während das Gerät eingeschaltet ist, wird eine gestrichelte Linie ausgedruckt.



Rundungsschalter: Zur Rundung des Endergebnisses einer Multiplikation oder Division auf eine vorher bestimmte Anzahl von Dezimalstellen. Die linke Stellung ist für das Aufrunden, die rechte für das Abrunden vorgesehen.

Beispiel: $5 + 9 = 0,5555 \dots$

Aufrunden

 $5 \div 9 = (0.556)$

Abrunden

 $5 \div 9 = (0.555)$

F (Virgule flottante): Tous les chiffres significatifs, jusqu'à un maximum de 12, sont imprimés ou affichés.

+ Mode "sommes monétaires": Les addition et les soustractions sont automatiquement effectuées avec deux décimales, plus besoin d'appuyer sur la touche \square à chaque entrée.

Commutateur d'imprimante

Si l'interrupteur de l'imprimante est réglé sur la position de marche (ON) alors que l'alimentation est enclenchée, une ligne pointillée est imprimée.



Sélection d'arrondi: Permet d'obtenir l'arrondi des résultats de multiplications et de divisions en fonction du nombre de décimales programmées. Position de gauche: arrondi au plus proche; position de droite: arrondi par défaut.

Exemple: $5 + 9 = 0,5555 \dots$

Arrondi au plus proche

 $5 \div 9 = (0.556)$

Arrondi par défaut

 $5 \div 9 = (0.555)$

F (Coma decimal flotante): Todos los numerales efectivos, hasta 12 dígitos, son impresos o indicados.

+(Add-Mode): Las sumas y restas se ejecutan automáticamente con 2 dígitos decimales.

No es necesario pulsar la tecla \square para entradas individuales.

Tecla de la impresora

Si el activador del impresor se enciende (ON) cuando la corriente está activada (ON), se imprimirá una línea de puntos.



Conmutador de redondeo: Sirve para redondear los resultados finales de multiplicaciones y divisiones en el número de dígitos decimales que se seleccionan. La posición izquierda permite redondeos por desprecio y la posición derecha redondeos por defecto.

Ejemplo: $5 + 9 = 0,5555 \dots$

Por desprecio

 $5 \div 9 = (0.556)$

Por defecto

 $5 \div 9 = (0.555)$

F (Virgola mobile): vengono visualizzati o stampati tutti i numeri rilevanti fino a 12 cifre.

+(Add-mode): Le addizioni e sottrazioni vengono effettuate automaticamente con 2 cifre di decimale.

Per le singole impostazioni non è necessario premere il tasto \square

Interruttore della stampatrice

Se l'interruttore della stampante venisse attivato mentre l'alimentazione è inserita, verrà stampata una linea punteggiata.



Interruttore di arrotondamento: per arrotondare il risultato finale di una moltiplicazione o divisione ad un numero prestabilito di cifre decimali. La posizione a sinistra è per l'arrotondamento per eccesso, quella a destra per l'arrotondamento per difetto.

Esempio: $5 + 9 = 0,5555 \dots$

Arrotondamento

 $5 \div 9 = (0.556)$

Arrotondamento per difetto

 $5 \div 9 = (0.555)$



Item Count Switch: Set the switch to the ITEM position, and when the or key is depressed, the number of times (up to 999) the and keys have been depressed is printed on the left-hand side of the paper. When this switch is set to ITEM and the or key is depressed, the number of times (up to 999) the and keys have been depressed is printed on the left-hand side of the paper. (See page 25.)



Schalter für Postenzähler: Durch Einstellung dieses Schalters auf ITEM und Drücken der oder -Taste wird auf der linken Seite des Papierstreifens ausgedruckt, wie oft die und -Tasten gedrückt wurden (bis zu 999). Durch Einstellung dieses Schalters auf ITEM und Betätigung der oder -Taste wird auf der linken Seite des Papierstreifens ausgedruckt, wie oft die und die -Tasten gedrückt wurden (bis zu 999). (Siehe Rechenbeispiel auf Seite 25.)



Compteur de postes: Lorsque ce commutateur est réglé sur la position ITEM et que l'on appuie sur la touche ou , le nombre de fois (pouvant aller jusqu'à 999) dont ont été enfoncées les touches et est imprimé du côté gauche du papier.

Lorsque ce commutateur est placé sur ITEM et que l'on appuie sur la touche ou le nombre de fois (jusqu'à 999) dont ont été enfoncées les touches et est imprimé sur le côté gauche du papier. (Voir les exemples de calcul à la page 25.)



Commutador Contador de Entradas: Coloque este conmutador en su posición ITEM. Cuando se pulsa la tecla o la de , se imprimirá al lado izquierdo del papel el número de veces (hasta 999) que hayan sido pulsadas las teclas y . Asimismo, cuando este conmutador se coloca en la posición ITEM y se pulsa la tecla o la de , se imprimirá al lado izquierdo del papel el número de veces (hasta 999) que hayan sido pulsadas las teclas y . (Para ejemplos de cálculos, refiérase a la página 25.)



Interruttore conta addendi: porre questo interruttore alla posizione ITEM, e quando il tasto o viene premuto, il numero di volte che i tasti e sono stati premuti (fino a 999 volte) verrà indicato sul lato sinistro della carta da stampa. Quando questo tasto viene posto alla posizione ITEM e i tasti o vengono premuti, il numero di volte che i tasti e sono stati premuti (fino a 999 volte) verrà indicato sul lato sinistro della carta da stampa. (Per esempi di calcolo vedere pagina 25.)



Multi-Numeric Fluorescent Display

- M** Memory sign: Lights up when the memory is in use.
- Overflow sign: Lights up when the calculator overflows.
- Minus sign: Indicates a negative number.

Display and Printing Functions: The display panel is convenient because numbers can be checked before depressing function keys and intermediate results can be verified.



Multinumerische Leuchtanzeige

- M** Speicherbelegungs-Zeichen: Leuchtet auf, wenn der Speicher belegt ist.
- Überlaufzeichen: Leuchtet bei Überlauf des Rechners auf.
- Minuszeichen: Zeigt einen negativen Wert an.

Anzeige- und Druckfunktionen: Das Anzeigefeld ist sehr praktisch, weil Zahlen vor dem Drücken von Funktionstasten und Zwischenergebnisse überprüft werden können.



Affichage multi-numérique fluorescent

- M** Témoin de mémoire: Indique que la mémoire est en service.
- Témoin de dépassement de la capacité: S'allume lorsque la capacité de la calculatrice est dépassée.
- Signe moins: Indique que la valeur affichée est négative.

Affichage et impression: Le panneau d'affichage est très pratique en ce sens qu'il permet de vérifier les valeurs numériques introduites avant d'actionner les touches de fonction d'une part, et les résultats intermédiaires, de l'autre.



Indicador multinumérico fluorescente

- M** Signo de memoria: Se enciende cuando se está utilizando la memoria.
- Signo de capacidad excedida: Se enciende cuando se ha excedido la capacidad de la calculadora.
- Signo menos: Indica un número negativo.

Funciones de indicación e impresión: El panel indicador es sumamente conveniente puesto que se pueden comprobar los números antes de pulsar las teclas de función pudiendo así verificar los resultados intermedios.

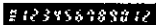

Quadrante fluorescente multinumerico

- M** Segno della memoria: si accende quando la memoria è operativa.
- Segno di eccedenza: si accende in caso di eccedenza.
- Segno meno: indica un numero negativo.

Funzioni del quadrante e della stampatrice: Il quadrante è molto comodo in quanto i numeri possono essere controllati prima di premere i tasti delle funzioni, e permette di verificare i risultati intermedi.

Example: $123+456+789=1368$

Operation	Display	Printout	
123	123.	123.00	+
456	456.	456.00	+
789	789.	789.00	+
	1368.	1,368.00	*

When printing is not required (i.e. the printer switch is OFF), the calculator can be used as an ordinary display model.

Beispiel: $123+456+789=1368$

Ausführung	Anzeige	Ausdruck	
123	123.	123.00	+
456	456.	456.00	+
789	789.	789.00	+
	1368.	1,368.00	*

Falls ein Ausdrucken nicht erforderlich ist (d.h. wenn sich der Druckwerkschalter auf OFF befindet), kann der Rechner als gewöhnliches Anzeigemodell verwendet werden.

Exemple: $123+456+789=1368$

Exécution	Affichage	Impression	
123	123.	123.00	+
456	456.	456.00	+
789	789.	789.00	+
	1368.	1,368.00	*

Lorsque l'on n'a pas besoin de l'impression (le commutateur d'imprimante se trouve sur OFF-arrêt), la calculatrice fonctionne comme un modèle ordinaire à simple affichage.

Ejemplo: $123+456+789=1368$

Operación	Indicador	Impresión	
123	123.	123.00	+
456	456.	456.00	+
789	789.	789.00	+
	1368.	1,368.00	*

Cuando no se requiere de impresión (esto es cuando se desconecta (OFF) el conmutador de la impresora), la calculadora puede ser utilizada como un modelo corriente de indicador.

Esempio: $123+456+789=1368$

Operazione	Quadrante	Stampa	
123	123.	123.00	+
456	456.	456.00	+
789	789.	789.00	+
	1368.	1,368.00	*

Quando la stampatrice non è operativa (cioè quando l'interruttore della stampatrice si trova su OFF), la calcolatrice può essere usata come un qualsiasi calcolatore senza stampa.

Key Roll-over System

The Canon P17-D uses the key roll-over system. If keys are depressed in rapid succession, the first key depressed is keyed in, followed by the next key, and the next, thus permitting fast operation.

Input Buffer Register Function:

The buffer register allows all numbers, basic function and other function keys to be depressed while numbers are being printed. The calculator remembers up to 9 key entries in the register, and calculates them in the sequence entered.

Tasten-Folge-System

Die Canon P17-D verwendet ein Tasten-Folge-System. Wenn die Tasten in schneller Folge betätigt werden, wird zunächst der erste Tastenwert eingegeben, dann der nächste und der nächste usw. Auf diese Weise wird ein schneller Betrieb gewährleistet.

Eingabe-Pufferregister:

Das Pufferregister ermöglicht eine Eingabe von Zahlen, Grund und anderen Funktionen durch Drücken der entsprechenden Tasten, während Zahlen ausgedruckt werden. Der Rechner speichert bis zu 9 Tasteneingaben in seinen Registern und berechnet sie in der Reihenfolge ihrer Eingabe.

Système de clavier "grande vitesse"

La Canon P17-D utilise le système de clavier "grande vitesse", ce qui signifie que si des touches sont actionnées en succession rapide, la première touche enfoncée est actionnée, suivie de la seconde et ainsi de suite, permettant un fonctionnement très rapide.

Clavier à mémoire tampon:

La mémoire-tampon du clavier permet d'actionner les touches numériques ou les touches de fonction alors même que l'impression d'un nombre précédent n'est pas terminée. Ce registre permet de mémoriser jusqu'à 9 frappes et de restituer ces informations dans l'ordre d'enregistrement.

Sistema de retención de las teclas pulsadas

La Canon P17-D utiliza un sistema de retención de las teclas pulsadas. Si se oprimen las teclas en una sucesión rápida, la primera tecla oprimida es registrada, seguida por la próxima tecla y la subsiguiente, permitiéndose así una rápida operación.

Función del registro tampón de entrada:

El registro tampón permite pulsar las teclas de todos los números, funciones básicas y otras funciones mientras se están imprimiendo otros números. La calculadora recuerda en sus registros las entradas de hasta 9 teclas y las calcula en la secuencia que han sido entradas.

Sistema di impostazione con memoria di transito

La Canon P17-D è dotata del sistema di impostazione a memoria di transito. Quando i tasti vengono premuti in successione rapida, il primo ad essere premuto viene subito attivato, seguito dal secondo e dai successivi in ordine, in modo da permettere un'impostazione rapida.

Funzione di separazione dei registri impostati:

Il registro di separazione permette di premere tutti i tasti numerici, quelli delle funzioni base e di altre funzioni, mentre la stampatrice è operativa. Questa calcolatrice ricorda fino a 9 impostazioni di dati nei registri, e li calcola secondo il loro ordine di impostazione.

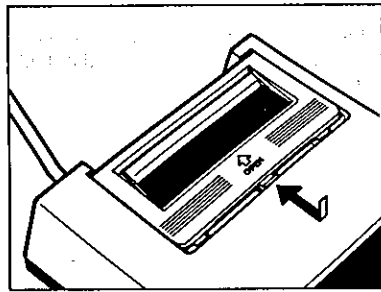

(1)

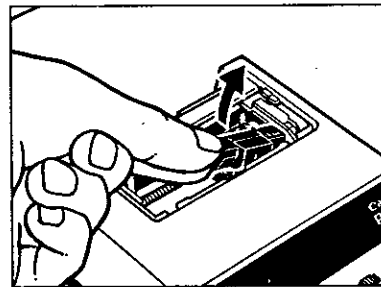

(2)

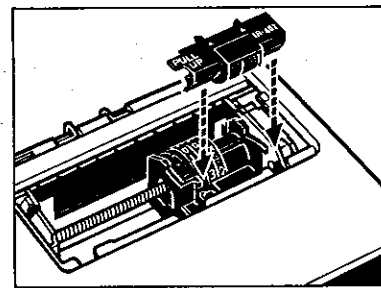

(3)

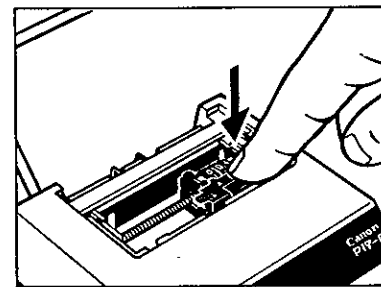

(4)

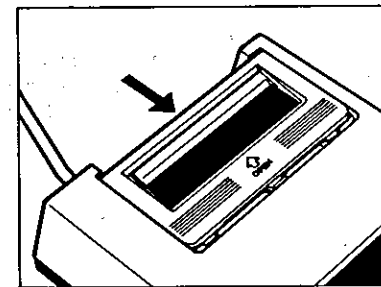

(5)

2. How to Replace the Ink Roller

- 1) Remove the printer cover by sliding it on the direction of the arrow.
- 2) Remove the ink roller by pulling up the tab on the left side.
- 3) Set the new ink roller as shown in figure 3.
- 4) 5) Push down on the center of ink roller until it clicks. Replace the cover.
 - For clear printing, change the ink roller after consuming about 6 rolls of printing paper.
 - Use only the Canon Ink Roller CP-13 for the P17-D.
 - Do not attempt to refill the ink roller, since this may cause mechanical difficulties.

2. Auswechseln der Farbrolle

- 1) Die Druckerabdeckung durch Schieben in Pfeilrichtung abnehmen.
- 2) Die Farbrolle durch Hochziehen der Zunge auf der linken Seite herausnehmen.
- 3) Eine neue Farbrolle wie in Abb. 3 gezeigt einsetzen.
- 4) 5) Die Farbrolle im Mittelteil herunterdrücken, bis sie einrastet. Die Abdeckung wieder anbringen.
 - Um ein deutliches Ausdrucken zu gewährleisten, sollten Sie die Farbrolle auswechseln, nachdem ungefähr 6 Papierrollen verbraucht wurden.
 - Nur die Canon Farbrolle CP-13 für den P17-D verwenden.
 - Nicht versuchen, die Farbrolle nachzufüllen, da dies zu Betriebsstörungen führen kann.

2. Remplacement du rouleau encreur

- 1) Retirer le capot de l'imprimante en le faisant glisser dans le sens de la flèche.
- 2) Retirer le rouleau encreur en soulevant la languette du côté gauche.
- 3) Mettre en place le nouveau rouleau encreur de la manière indiquée à la figure 3.
- 4) 5) Enfoncer le centre du rouleau encreur jusqu'au dé clic. Remettre en place le capot.
 - Pour conserver une impression nette, changer le rouleau encreur tous les 6 rouleaux de papier environ.
 - N'utiliser que le rouleau encreur Canon CP-13 pour le modèle P17-D.
 - Ne pas tenter de remplir le rouleau encreur, car cela pourrait provoquer des problèmes mécaniques.

2. Reemplazo del rodillo entintador

- 1) Quite la tapa del impresor, deslizando la en la dirección de la flecha.
- 2) Quite el rodillo de tinta levantando la perilla del lado izquierdo.
- 3) Coloque el nuevo rodillo tal y como se muestra en el dibujo 3.
- 4) 5) Presione sobre el centro del rodillo hasta que produzca un sonido. Vuelva a colocar la tapa.
 - Para mantener la impresión clara, cambie el rodillo entintador una vez que haya utilizado cerca de 6 rollos de papel de imprimir.
 - Use únicamente el rodillo entintador CP-13 Canon para el modelo P17-D.
 - No trate de volver a llenar el rodillo entintador ya que ello puede causar problemas mecánicos.

2. Sostituzione del rullo a inchiostro

- 1) Togliere il coperchio della stampante facendolo scorrere verso la direzione indicata dalla freccia.
- 2) Togliere il rullo a inchiostro sollevando la levetta posta al lato sinistro.
- 3) Inserire il nuovo rullo a inchiostro nel modo indicato nella figura 3.
- 4) 5) Premere sulla parte centrale del rullo fino ad assestarlo in posizione con un click meccanico. Porre il coperchio alla posizione originale.
 - Per una stampa chiara, cambiare il rullo dell'inchiostro dopo aver usato circa 6 rulli di carta.
 - Usare solamente rulli a inchiostro Canon CP-13 per la P17-D.
 - Evitare di riempire il rullo a inchiostro onde evitare possibili danni alle parti meccaniche.

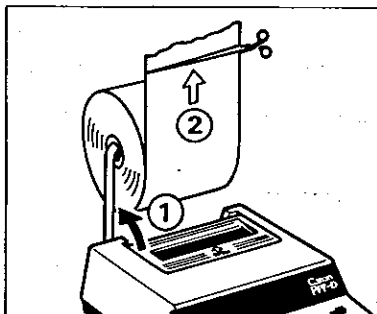

(A)

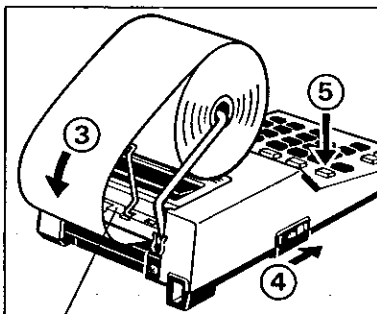

Paper deflection hook
Papierumlenkhaken
Crochet de pliage du papier
Gancho de desviación de papel
Premicarta

(B)

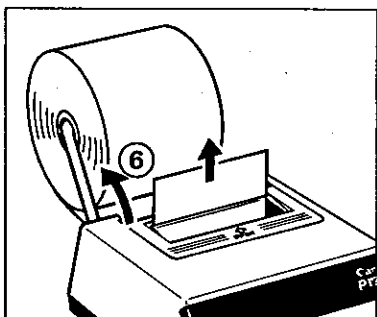

(C)

3. How to Insert Printing Paper

- 1) Lift up the arm and insert the printing paper on the shaft.
 - 2) The edge of the paper should be positioned as shown in the figure (↑).
 - 3) Pull the arm with the attached printing paper forward. Lift the paper deflection hook and insert the edge of the paper into the slit as far as possible.
 - 4) Turn the power switch ON.
 - 5) Press the paper feed key to advance the paper.
 - 6) As the paper begins to advance, push the arm back to its original position.
- For the printing paper size, refer to the specification. (See page 29)
 - Paper rolls of different size may cause mechanical failure.

3. Einlegen einer neuen Papierrolle

- 1) Heben Sie den Arm nach oben und setzen Sie die Papierrolle auf die Achse.
 - 2) Die Papierkante sollte sich in der aus der Abbildung ersichtlichen Lage befinden (↑).
 - 3) Ziehen sie den Arm mit der eingesetzten Papierrolle nach vorn. Heben Sie den Papierumlenkhaken an und schieben Sie die Papierkante möglichst weit in den Schlitz.
 - 4) Stellen Sie den Ein-Aus-Schalter auf ON (Ein).
 - 5) Drücken Sie die Papiertransporttaste, um das Papier zu transportieren.
 - 6) Wenn der Papiervorschub beginnt, drücken Sie den Arm auf dessen Ausgangsstellung zurück.
- Über Druckpapier, bitte vergleichen Sie Technische Daten. (s.S. 29)
 - Papierrollen anderer Größen können zu mechanischem Versagen führen.

3. Mise en place du papier d'impression

- 1) Soulever le bras et insérer le papier d'impression sur l'axe.
 - 2) L'arête du papier doit être disposée comme l'indique le figure (↑).
 - 3) Tirer vers l'avant le bras sur lequel le papier d'impression est attaché. Soulever le crochet de pliage du papier et insérer l'arête du papier aussi loin que possible dans la fente.
 - 4) Allumer (ON) l'interrupteur du courant électrique.
 - 5) Actionner la touche d'avancement du papier.
 - 6) Tandis que le papier avance, repousser le bras à sa position originale.
- A propos de la taille du papier d'impression, consulter la fiche technique. (Voir page 29)
 - Des rouleaux de dimensions différentes risquent d'endommager la machine.

3. Colocación del papel de imprimir

- 1) Levante la barra e inserte el papel de imprimir en el eje.
 - 2) El borde del papel deberá quedar en la posición mostrada por la figura (↑).
 - 3) Tire de la barra hacia delante con el papel de imprimir ya colocado. Levante el gancho de desviación de papel e inserte el borde del papel en la ranura lo más lejos posible.
 - 4) Conecte (ON) el conmutador de energía.
 - 5) Oprima la tecla de avance del papel para que éste avance.
 - 6) Cuando el papel comienza a avanzar, oprima la barra hacia atrás y déjela ajustada a su posición original.
- Consulte las especificaciones para el papel de imprimir. (Véase la página 29)
 - El uso de rollos de papel de otras dimensiones puede ocasionar averías mecánicas.

3. Come inserire la carta da stampa

- 1) Alzare il braccio e inserire la carta sull'asta.
 - 2) Il bordo della carta deve essere come si vede nella figura (↑).
 - 3) Spingere in avanti il braccio con la carta. Alzare il premicarta e inserire il più avanti possibile l'estremità della carta nella fessura.
 - 4) Mettere l'interruttore in posizione ON.
 - 5) Premere il tasto di avanzamento della carta.
 - 6) Mentre la carta comincia ad avanzare, spingere il braccio nella sua posizione originale.
- Per quanto riguarda la grandezza dell'area di stampa, vedere i dati tecnici (a pag. 29).
 - Rotoli di dimensioni diverse da queste indicate possono causare guasti meccanici.

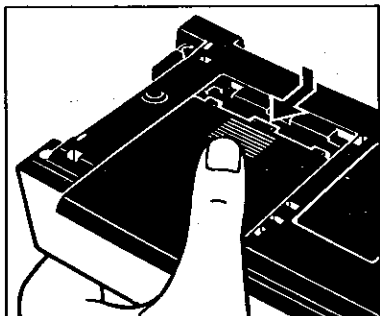

(1)

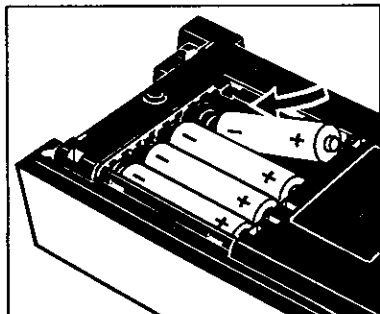

(2)

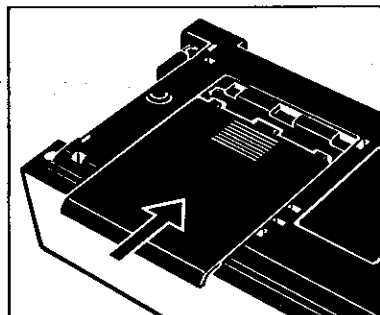

(3)

4. How to Load and Replace Dry Batteries

Loading

- 1) Remove the cover of the battery chamber on the bottom of the P17-D by sliding it in the direction of the arrow.
 - 2) Load four new penlight batteries (size AA) into the battery chamber as illustrated, by inserting the (-) end first.
 - 3) Replace the cover.
- The P17-D will not operate if batteries are loaded improperly.

4. Einlegen und Auswechseln der Trockenbatterien

Einlegen

- 1) Den Deckel des Batteriefaches unten am P17-D durch Schieben in Pfeilrichtung entfernen.
 - 2) Vier neue Stabbatterien (Format AA) entsprechend der Abbildung in das Batteriefach einlegen, wobei der (-) Pol zuerst eingeschoben wird.
 - 3) Den Deckel wieder aufsetzen.
- Wenn die Batterien falsch eingelegt sind, arbeitet der P17-D nicht.

4. Mise en place et remplacement des piles

Mise en place

- 1) Oter le couvercle du compartiment de piles situé sous la P17-D, ceci en le faisant coulisser dans le sens de la flèche.
 - 2) Introduire quatre piles bâton neuves (taille AA) dans le compartiment de piles en commençant par introduire la polarité (-), ceci de la manière indiquée.
 - 3) Remettre le couvercle en place.
- La P17-D ne fonctionnera pas si les piles sont mal disposées dans la cassette.

4. Carga y reemplazo de las pilas

Carga



- 1) Extraer la tapa del compartimiento de las pilas ubicado en la parte inferior de la P17-D, deslizando en la dirección de la flecha.
 - 2) Insertar cuatro pilas nuevas 'penlight' (tamaño AA) en el compartimiento de las pilas tal y como se ilustra, insertando en primer lugar el extremo (-).
 - 3) Volver a colocar la tapa.
- La P17-D no funcionará si las pilas se cargan inadecuadamente.

4. Sostituzione delle batterie

Inserimento



- 1) Togliere il coperchio dello scompartimento delle batterie sul fondo del P17-D, facendolo scorrere nel senso della freccia.
 - 2) Inserire quattro batterie cilindriche (formato AA) nello scompartimento nel modo illustrato. Inserire dapprima il polo negativo (-).
 - 3) Rimettere il coperchio.
- Il P17-D non funziona se le batterie non sono inserite correttamente.

Replacement

Low battery voltage may cause printing defects, random paper advances or the inability of the  key to clear the overflow when the  switch is at ON.



- Be sure to take the batteries out of the calculator if it is not to be used for more than one month.

Auswechseln

Niedrige Batteriespannung kann Fehler beim Drucken und unregelmäßigen Papiervorschub verursachen oder dazu führen, daß Betätigung der  Taste den Überlauf nicht aufhebt, wenn gleichzeitig die  Taste auf ON steht.



- Wenn der Rechner länger als einen Monat nicht benutzt wird, sollten die Batterien unbedingt herausgenommen werden.

Remplacement

Lorsque la tension des piles est trop basse, ceci peut donner lieu à des défauts d'impression, un avancement inattendu du ruban de papier ou à une incapacité de la touche  de déverrouiller la calculatrice après un dépassement de capacité lorsque le commutateur  est sur ON.



- Si on ne prévoit pas d'utiliser la calculatrice pendant plus d'un mois, veiller à en retirer les piles.

Reemplazo

Una baja carga (voltaje) de las pilas puede causar defectos de impresión, avances irregulares del papel o la imposibilidad de que la tecla  borre la capacidad excedida cuando el interruptor  está en ON.

- Tome la precaución de sacar las pilas de la calculadora si no la va a utilizar durante más de un mes.

Sostituzione

L'abbassamento del voltaggio delle batterie può provocare difetti di stampa, avanzamento irregolare della carta o l'incapacità, da parte del tasto , di azzerare l'eccedenza quando il deviatore  è in posizione ON.

- Se non si usa la calcolatrice per più di un mese, togliere le batterie.

Battery Life

1. With intermittent use (30 minutes and 100 lines every day)
High performance manganese batteries about 23 days
Alkaline manganese batteries about 42 days
2. With continuous use
High performance manganese batteries prints about 7,000 lines
Alkaline manganese batteries prints about 16,000 lines
3. With display use only
High performance manganese batteries up to 14 hours
Alkaline manganese batteries up to 24 hours

Lebensdauer von Batterien

1. Betrieb mit Unterbrechungen (täglich 30 Minuten bzw. 100 Zeilen)
Hochleistungsmanganbatterien etwa 23 Tage
Alkalimanganbatterien etwa 42 Tage
2. Betrieb ohne Unterbrechungen
Hochleistungsmanganbatterien etwa 7.000 Linien
Alkalimanganbatterien etwa 16.000 Linien
3. Anzeige allein
Hochleistungsmanganbatterien ungefähr 14 Stunden
Alkalimanganbatterien ungefähr 24 Stunden

Autonomie des piles

1. Usage intermittent (30 minutes ou 100 lignes par jour)
Piles au manganèse (haut rendement) env. 23 jours
Piles alcalines au manganèse env. 42 jours
2. Usage ininterrompu
Piles au manganèse (haut rendement) env. 7.000 lignes
Piles alcalines au manganèse env. 16.000 lignes
3. Affichage seulement
Piles au manganèse (haut rendement) env. 14 heures
Piles alcalines au manganèse env. 24 heures

Vida útil de las pilas

1. Con uso intermitente (30 minutos o 100 líneas diariamente)
Pilas de manganeso de alto rendimiento aprox. 23 días
Pilas alcalinas de manganeso aprox. 42 días
2. Con uso continuo
Pilas de manganeso de alto rendimiento aprox. 7.000 líneas
Pilas alcalinas de manganeso aprox. 16.000 líneas
3. Con uso del indicador solamente
Pilas de manganeso de alto rendimiento aprox. 14 horas
Pilas alcalinas de manganeso aprox. 24 horas

Durata delle batterie

1. In caso di uso intermittente (30 minuti o 100 linee al giorno)
Batterie al manganese di alto rendimento circa 23 giorni
Batterie alcaline al manganese circa 42 giorni
2. In caso di uso continuo, senza Interruzione
Batterie al manganese di alto rendimento circa 7.000 linee
Batterie alcaline al manganese circa 16.000 linee
3. In caso di solo uso del display
Batterie al manganese di alto rendimento circa 14 ore
Batterie alcaline al manganese circa 24 ore

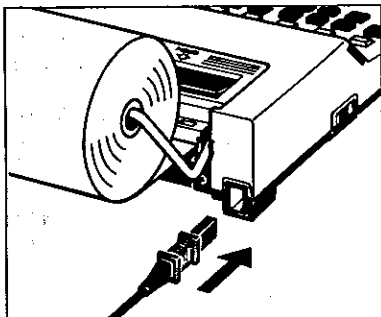

5. Canon AC Adapter AD-4II (Optional)

- 1) Use only the Canon AC Adapter AD-4II with the P17-D.
- 2) Turn the Power Switch of the calculator OFF before connecting or disconnecting the AC Adapter.

5. Canon-Wechselstrom-Adapter AD-4II (Sonderzubehör)

- 1) Für den P17-D nur den Canon-Wechselstrom-Adapter AD-4II verwenden.
- 2) Schalten Sie den Ein-Aus-Schalter des Rechners vor dem Anschließen oder Trennen des Wechselstrom-Adapters aus.

5. Adaptateur c.a. Canon AD-4II (En option)

- 1) Pour la calculatrice P17-D utiliser exclusivement l'adaptateur c.a. Canon AD-4II.
- 2) Avant de brancher ou de débrancher la calculatrice de son adaptateur c.a., couper l'interrupteur principal de la calculatrice.

5. Adaptador de CA AD-4II Canon (Opcional)

- 1) Utilice sólo el adaptador AD-4II de CA Canon con la P17-D.
- 2) Desconecte el interruptor de energía de la calculadora antes de conectarla o desconectarla del adaptador de CA.

5. Adattatore per CA AD-4II Canon (Opzionale)

- 1) Usare solamente l'adattatore per CA AD-4II Canon per la P17-D.
- 2) Chiudere l'interruttore di alimentazione della calcolatrice prima di collegare o disinnestare l'adattatore per CA.

6. The NiCd Battery (Optional)

The NiCd Battery Pack 7 for the P17-D is available. Load the NiCd Battery Pack 7 into the battery chamber on the bottom of the P17-D. Low battery voltage may cause printing defects, random paper advances or malfunctions when using the [C] key to clear the overflow. If one of the above occurs, recharge the NiCd Battery with the Canon AC adapter AD-4II.

- When the NiCd battery is first used or after long storage, the full charge of 15 hours may not yield the specified length of usage. In this case, repeat the charging four or five times.

6. Der NiCd-Akku (Sonderzubehör)

Für den P17-D ist ein NiCd Batterieeinsetz 7 erhältlich. Den NiCd Batterieeinsetz 7 in das Batteriefach unten am P17-D einlegen. Durch niedrige Akkuspannung können fehlerhaftes Ausdrucken, unregelmäßiger Papierstreifentransport oder bei Betätigung der Taste [C] zur Überlauflöschung Betriebsstörungen verursacht werden. Beim Auftreten dieser Störungen den NiCd-Akku mit dem Canon-Wechselstrom-Adapter AD-4II aufladen.

- Wird der NiCd Batterieeinsetz erstmalig oder nach längerer Lagerung benutzt, ist es möglich, daß mit vollständiger Aufladung nicht die angegebene Betriebsdauer erreicht wird. In diesem Falle wie-

6. La batterie au NiCd (En option)

Une alimentation à piles NiCd est disponible pour la P17-D. Introduire l'accu 7 au NiCd dans le compartiment de piles situé en dessous de la P17-D. Lorsque la tension baisse, l'impression devient défectueuse et le papier avance de manière intempestive. Il arrive également que la touche [C] devienne inopérante lorsque l'on désire déverrouiller la calculatrice après un dépassement de capacité. Si l'un de ces trois phénomènes se produit, il est nécessaire de procéder au rechargement de la batterie au NiCd à l'aide de l'adaptateur de CA AD-4II.

- Lors de la première mise en service ou après avoir été remise

6. La pila NiCd (Opcional)

Tenemos en existencia paquetes de pilas de NiCd para el modelo P17-D. Inserte el paquete de pilas de NiCd 7 en el compartimiento de las pilas ubicado en la parte inferior de la P17-D. Un bajo voltaje de la pila puede causar defectos en la impresión, avances irregulares del papel o malfuncionamiento al usar la tecla [C] para borrar la capacidad excedida. Si cualquiera de estas anomalías ocurriera, recargue la pila de NiCd con el Adaptador de CA AD-4II Canon.

- Cuando se vaya a utilizar la pila NiCd por primera vez, o después de haberla tenido guardada durante un período prolongado, la carga completa de 15 horas no puede satisfacer el período de

6. La Batteria al NiCd (Opzionale)

Una portabatteria a NiCd è disponibile per la P17-D. Inserire il portabatteria al NiCd 7 nello scompartimento delle batterie sul fondo della P17-D. L'abbassamento del voltaggio della batteria può causare difetti di stampa, avanzamento irregolare della carta, o malfunzionamento quando si usa il tasto [C] per azzerare le eccedenze. Se si verifica uno di questi inconvenienti, ricaricare la batteria NiCd con l'adattatore per CA AD-4II.

- Se la batteria al NiCd viene usata per la prima volta o dopo un lungo periodo di conservazione, una carica piena di 15 ore potrebbe non fornire la durata specifica di funzionamento. Ripetere

- To charge the NiCd Battery, turn the Power Switch off and insert the output plug of the AC adapter AD-4II into the jack of the calculator. Then plug the AC adapter AD-4II into an electrical outlet.
- A full charge takes about 15 hours.

derholen Sie das Aufladen vier oder fünf Mal.

- Um den NiCd-Akku aufzuladen, sollten Sie den Ein-Aus-Schalter ausschalten und den Ausgangskabelstecker des Wechselstrom-Adapter AD-4II in die Buchse des Rechners stecken. Dann stecken Sie das Wechselstrom-Adapter AD-4II in eine Netzsteckdose.
- Für eine volle Aufladung werden ungefähr 15 Stunden benötigt.

pendant une longue période, il peut arriver qu'une recharge de 15 heures n'assure pas à la calculatrice l'autonomie de fonctionnement spécifiée; celle-ci ne peut alors être atteinte qu'au bout de 4 ou 5 recharges.

- Pour procéder à cette recharge, régler l'interrupteur de la calculatrice sur arrêt (OFF) et introduire la fiche de l'adaptateur c.a. AD-4II dans la prise correspondante de la machine; brancher ensuite le chargeur sur une prise secteur.
- Une charge complète exige environ 15 heures.

utilización. En tal caso, repita la operación de recarga cuatro o cinco veces.

- Para efectuar la recarga, desconecte el interruptor de energía e inserte el enchufe de salida del adaptador de CA AD-4II Canon en la clavija de la calculadora. A continuación, enchufe el adaptador de CA AD-4II Canon a la fuente eléctrica.
- Tarda unas 15 horas la recarga completa.
- Una recarga completa permite utilizar la calculadora durante la impresión de 1/2 rollo de papel de imprimir. (Cuando se utiliza solamente el indicador, la calculadora puede ser utilizada durante unas 13 horas aproximadamente.)

allora la ricarica cinque o sei volte.

- Per ricaricare la batteria al NiCd, spegnere l'interruttore di corrente mettendolo su OFF e inserire la spina del adattatore per CA AD-4II nella presa di raccordo della calcolatrice. Collegare quindi il caricatore con una presa della corrente.
- Per una piena ricarica ci vogliono circa 15 ore.

- With a full charge it is possible to use the calculator for 1/2 rolls of printing paper. (The calculator can be used for approximately 13 hours when only the display is used.)
- Disconnect AC adapter AD-4II when using the calculator.
- Please note that the calculator can be operated with the AC adapter AD-4II plugged into an electrical outlet. In this case, however, the battery can overcharge if the calculator is not used for a long period of time.

- Do not leave the calculator charging for more than 4 days.
- If the NiCd battery only gives a short period of use even after it has been properly recharged a number of times, it means that it has reached the end of its service life, and it should be replaced.

- Bei voller Aufladung kann der Rechner für 1/2 Rollen Druckpapier verwendet werden. (Der Rechner kann ungefähr 13 Stunden lang betrieben werden, wenn nur die Anzeige verwendet wird.)
- Es ist ratsam, das Wechselstrom-Adapter bei Benutzung des Rechners abzutrennen.
- Beachten Sie bitte, daß der Rechner betrieben werden kann, wenn das Wechselstrom-Adapter in einer Netzsteckdose steckt. In diesem Falle kann der Akku jedoch zu stark aufgeladen werden, wenn der Rechner längere Zeit nicht benutzt wird.

- Laden Sie den Rechner nicht länger als 4 Tage auf.
- Falls der Akku selbst nach mehrmaligem Aufladen nur kurzzeitig Leistung abgibt, so ist dieses ein Zeichen dafür, daß das Ende seiner Lebensdauer erreicht wurde. Er sollte daher durch einen neuen ersetzt werden.

- A pleine charge, l'autonomie de la calculatrice est de 1/2 rouleaux de papier; elle est d'environ 13 heures si on n'utilise que la fonction d'affichage.
- Il est recommandé de débrancher le chargeur quand on utilise la machine.
- Prière de noter que la calculatrice peut être utilisée pendant que l'adaptateur CA AD-4II reste branché sur une prise secteur; toutefois, il y a alors risque de surcharge si la machine n'est pas utilisée pendant une période suffisante.

- Ne pas prolonger la recharge de la calculatrice au-delà de 4 jours.
- Lorsque l'autonomie de fonctionnement de la machine se réduit en dépit de recharges complètes répétées, c'est le signe que la durée de vie de l'accumulateur se termine; il doit alors être remplacé.

- Se aconseja desconectar el adaptador de CA AD-4II Canon cuando se esté utilizando la calculadora.
- Tenga presente que la calculadora puede funcionar con el adaptador de CA AD-4II Canon enchufado a la fuente eléctrica. En este caso, sin embargo, la pila podría sobrecargarse si no se utilizara durante un prolongado período de tiempo.

- No deje que la calculadora se esté recargando durante más de 4 días.
- Si la pila proporciona un período corto de alimentación, incluso después de haber sido recargada correctamente varias veces, significa que ha alcanzado el final de su duración de servicio, por lo que deberá entonces reemplazarla.

- L'autonomia della ricarica permette la stampa 1/2 rotoli di carta. (Usando soltanto la funzione del quadrante, la calculatrice può essere usata per circa 13 ore.)
- Si raccomanda di disinserire il l'adattore per CA AD-4II durante l'uso della calculatrice.
- La calculatrice può essere operata con l'adattore per CA AD-4II inserito nella presa di corrente. Tuttavia, se essa non viene usata per un lungo periodo di tempo, la batteria può sovraccaricarsi.

- La batteria non deve essere ricaricata per più di 4 giorni.
- Se la batteria funziona soltanto per poco tempo anche dopo essere stata ricaricata diverse volte, vuol dire che ormai ha raggiunto il limite della sua operabilità. In tal caso, essa deve essere sostituita.

7. Overflow Interlock Function

"←" lights up on the display and a broken line is printed in the following overflow cases:

1. When the result or the memory contents exceed 12 digits to the left of the decimal point.

Example 1: Overflow of addition and subtraction

Operation	Display	Printout	
999999999999 +	999999999999	999,999,999,999	+
999999999999 +	← 1.999999999999	999,999,999,999	+

		1999999999998	*

7. Funktion der Überlaufsperr

In den folgenden Überlauffällen leuchtet "←" auf der Anzeige auf, und eine gestrichelte Linie wird ausgedruckt.

1. Wenn der ganzzahlige Teil des Ergebnisses oder Speicherinhalts 12 Stellen überschreitet.

Beispiel 1: Überlauf bei Addition und Subtraktion

Ausführung	Anzeige	Ausdruck	
999999999999 +	999999999999	999,999,999,999	+
999999999999 +	← 1.999999999999	999,999,999,999	+

		1999999999998	*

7. Dépassement de capacité

Dans les cas suivants, on a un dépassement de capacité: le témoin "←" s'allume sur l'affichage et une ligne discontinue s'imprime sur le papier.

1. Lorsque le résultat ou le contenu de la mémoire dépasse 12 chiffres à la gauche de la virgule.

Exemple 1: Dépassement en addition et soustraction

Exécution	Affichage	Impression	
999999999999 +	999999999999	999,999,999,999	+
999999999999 +	← 1.999999999999	999,999,999,999	+

		1999999999998	*

7. Función de inmovilización por capacidad excedida

En los siguientes casos de capacidad excedida se enciende "←" en el indicador y se imprime una línea de guiones:

1. Cuando el resultado o el contenido de la memoria excede de 12 dígitos a la izquierda del punto decimal.

Ejemplo 1: Capacidad excedida por suma y resta

Operación	Indicador	Impresión	
999999999999 +	999999999999	999,999,999,999	+
999999999999 +	← 1.999999999999	999,999,999,999	+

		1999999999998	*

7. Blocco a causa di eccedenza

Nei casi seguenti di eccedenza, sul quadrante appare la lettera "←" e sulla carta si stampa una linea tratteggiata:

1. Quando il risultato o il contenuto della memoria supera le 12 cifre alla sinistra del punto decimale.

Esempio 1: Eccedenza dell'addizione e sottrazione

Operazione	Quadrante	Stampa	
999999999999 +	999999999999	999,999,999,999	+
999999999999 +	← 1.999999999999	999,999,999,999	+

		1999999999998	*

Example 2: Overflow of multiplication and division

Operation	Display	Printout	
123456 <input type="checkbox"/>	123456.	123,456•	X
567890 <input type="checkbox"/>	70109427840.	567,890•	X
2000 <input type="checkbox"/>	←140.218855680	2,000•	=

(Correct answer: 140218855680000.)

2. When dividing by "0".

140•218855680 *

3. Buffer Register Overflow

When the sequential operation is made using more than 9 keys; depress the key or the key to clear the overflow.

4. If the batteries are weak, the or key may not unlock the keyboard when the Printer switch is at ON. In this case, turn the Printer switch OFF and unlock the keyboard with key only. The calculation can be continued without printing.

Beispiel 2: Überlauf bei Multiplikation und Division

Ausführung	Anzeige	Ausdruck	
123456 <input type="checkbox"/>	123456.	123,456•	X
567890 <input type="checkbox"/>	70109427840.	567,890•	X
2000 <input type="checkbox"/>	←140.218855680	2,000•	=

(Richtiges Ergebnis:

140218855680000.)

2. Beim Dividieren durch "0".

140•218855680 *

3. Pufferregisterüberlauf

Wenn mehr als 9 Tasten in einer Folge für Eingabe betätigt werden: Die Taste oder die Taste drücken, um den Überlauf zu löschen.

4. Wenn jedoch die Batterien schwach sind, kann es vorkommen, daß Betätigung der oder der Taste die Eintast Sperre nicht aufhebt, wenn gleichzeitig der Druckwerkschalter auf ON steht. Wenn dies vorkommt, ist der Druckwerkschalter abzuschalten; dann wird die Tastatur durch Drücken der Taste allein aufgehoben. Mit der Rechnung kann ohne Ausdrucken weitergefahren werden.

Exemple 2: Dépassement en multiplication et division

Exécution	Affichage	Impression	
123456 <input type="checkbox"/>	123456.	123,456•	X
567890 <input type="checkbox"/>	70109427840.	567,890•	X
2000 <input type="checkbox"/>	←140.218855680	2,000•	=

(Réponse exacte:

140218855680000.)

2. Division par "0".

140•218855680 *

3. Dépassement de registre-tampon

Quand on actionne en succession rapide plus de 9 touches; annuler par une pression sur la touche ou la touche .

4. Si la tension des piles est trop basse, les touches et sont parfois incapables de déverrouiller le clavier après un dépassement de capacité lorsque le commutateur d'imprimante est sur ON. Dans un tel cas, mettre le commutateur d'imprimante sur OFF et déverrouiller la calculatrice à l'aide de la touche seulement. Les calculs peuvent être poursuivis sur l'affichage seul.

Ejemplo 2: Capacidad excedida por multiplicación y división

Operación	Indicador	Impresión	
123456 <input type="checkbox"/>	123456.	123,456•	X
567890 <input type="checkbox"/>	70109427840.	567,890•	X
2000 <input type="checkbox"/>	←140.218855680	2,000•	=

(Respuesta correcta:

140218855680000.)

2. Al dividir entre "0".

140•218855680 *

3. Capacidad excedida en el registro tampón

Quando se ejecuta una operación en secuencia con más de 9 teclas; oprima la tecla o la tecla para borrar la capacidad excedida.

4. Sin embargo, si las pilas están débiles, las teclas o pueden no eliminar las cifras introducidas cuando el interruptor de la impresora está en ON. En este caso, apague el interruptor de la impresora y entonces puede borrar las cifras introducidas con la tecla solamente. Los cálculos se pueden continuar sin imprimirse.

Esempio 2: Eccedenza della moltiplicazione e divisione

Operazione	Quadrante	Stampa	
123456 <input type="checkbox"/>	123456.	123,456•	X
567890 <input type="checkbox"/>	70109427840.	567,890•	X
2000 <input type="checkbox"/>	←140.218855680	2,000•	=

(Risultato corretto:

140218855680000.)

2. Quando il divisore è uguale a "0".

140•218855680 *

3. Eccedenza dei registri di separazione

Quando l'ordine delle operazioni viene effettuato con più di 9 tasti. Per eliminare l'eccedenza premere il tasto o il tasto .

4. Se le batterie sono deboli, tuttavia, i tasti o possono divenire incapaci di sbloccare la tastiera quando il deviatore della stampatrice è in posizione ON. In tal caso, mettere il deviatore della stampatrice in posizione OFF; si sarà così in grado di sbloccare la tastiera con il solo tasto . Il calcolo può essere continuato senza stampa.

8. Calculation Examples









Rechenbeispiele



Exemples de calculs



Ejemplos de cálculos



Esempi di calcolo











	Example Beispiel Exemple Ejemplo Esempio	Setting Einstellung Réglage Ajuste Sistemazione	Operation Ausführung Exécution Operación Operazioni sulla tastiera	Printout Ausdruck Impression Impresión Stampa
Addition and Subtraction	2		2 +	2.00 +
Addition und Subtraktion	3		3 +	3.00 +
Addition et soustraction	+ 4		4 +	4.00 +
Suma y resta	(9)		*	9.00 *
Addizioni e sottrazioni	3		3 +	Red 3.00 +
	-5		5 -	Rot 5.00 -
	(-2)		*	Rouge 2.00 *
				Rojo -2.00 *
				Rosso
Repetitive Entry of Result	2.5		2.5 +	2.50 +
Wiederholung des Ergebnisses	+ 2.5		+	2.50 +
Répétition d'une entrée	(5.0)		*	5.00 *
Entradas reiterativas de resultados	5		+	5.00 +
Impostazione ripetuta di un risultato	5		+	Red 5.00 +
	-5		+	Rot 5.00 +
	(5.0)		-	Rouge 5.00 -
			*	Rojo 5.00 -
				Rosso 5.00 *
Printing of Intermediate Result	123		123 +	123.00 +
Ausdruck des Zwischenergebnisses	456		456 +	456.00 +
Impression d'un résultat intermédiaire	+ 789		789 +	789.00 +
Impresión de resultados intermedios	(1,368)		*	Red 1,368.00 ◊
Stampa del risultato intermedio	-321		321 -	Rouge 321.00 -
	(1,047)		*	Rojo 1,047.00 *
				Rosso
Add-Mode Calculation	\$12.55		1255 +	12.55 +
Kurzweg-Addition/Subtraktion	15.75		1575 +	15.75 +
Calcul en mode "sommes monétaires"	4.20		420 +	Red 4.20 +
Cálculos con Add-mode	-10.45		1045 -	Rouge 10.45 -
Calcoli in add-mode	-5.30		530 -	Rojo 5.30 -
	(\$16.75)		*	Rosso 16.75 *

Multiplication Multiplikation Multiplication Multipliación Moltiplicazione	$123 \times 456 = (56,088)$		123 <input type="checkbox"/> \times 456 <input type="checkbox"/> $=$	123 • \times - 456 • $=$ 56,088 • 000 $*$
	$(-2) \times 3 = (-6)$		<input type="checkbox"/> 2 <input type="checkbox"/> \times 3 <input type="checkbox"/> $=$	Red } 2 • 00 - Rot } -2 • 00 \times Rouge } 3 • = Rojo } -6 • 000 $*$ Rosso }
Division Division Division División Divisione	$456 \div 123 = (3.707)$		456 <input type="checkbox"/> \div 123 <input type="checkbox"/> $=$	456 • \div 123 • = 3 • 707 $*$
	$(-365) \div 7 = (-52.143)$		<input type="checkbox"/> 365 <input type="checkbox"/> \div 7 <input type="checkbox"/> $=$	Red } 365 • 000 - Rot } -365 • 000 \div Rouge } 7 • = Rojo } -52 • 143 $*$ Rosso }
Chain Multiplication and Division Kettenmultiplikation und -division Multiplications et divisions en chaîne Multipliación y división en cadena Moltiplicazioni e divisioni a catena	1) $2.5 \times 6.24 \times 8.365 = (130.494)$		2.5 <input type="checkbox"/> \times 6.24 <input type="checkbox"/> \times 8.365 <input type="checkbox"/> $=$	2 • 5 \times 6 • 24 \times 8 • 365 = 130 • 494 $*$
	2) $5,000 \div 3.21 \times 9.87 = (15,373.8317756)$		5000 <input type="checkbox"/> \div 3.21 <input type="checkbox"/> \times 9.87 <input type="checkbox"/> $=$	5,000 • \div 3 • 21 \times 9 • 87 = 15,373 • 8317756 $*$
	3) $7,894 \times 567 + 0.032 = (139,871,812.5)$		7894 <input type="checkbox"/> \times 567 <input type="checkbox"/> \div .032 <input type="checkbox"/> $=$	7,894 • \times 567 • \div 0 • 032 = 139,871,812 • 5 $*$
Mixed Calculation Mischrechnung Calculs mixtes Cálculo mixto Calcoli misti	$2 + 3 \times 4 - 5 = (9)$		<input type="checkbox"/> 2 <input type="checkbox"/> $+$ 3 <input type="checkbox"/> \times 4 <input type="checkbox"/> $=$	2 • 00 $+$ 3 • \times 4 • = 12 • 00 $*$
			5 <input type="checkbox"/> $+$ 5 <input type="checkbox"/> $-$ 5 <input type="checkbox"/> $*$	Red } 12 • 00 $+$ Rot } 5 • 00 - Rouge } 9 • 00 $*$ Rojo } Rosso }

Sum and Difference of Products and Quotients	$1,500 \times 40 = (60,000)$		1500 <input checked="" type="checkbox"/>	1,500• x
Summe und Differenz von Produkten und Quotienten	$1,200 \times 30 = (36,000)$		40 <input type="checkbox"/>	40• =
Sommes et différences de produits et de quotients	$-) 1,000 + 20 = (50)$			60,000•00 *
Suma y diferencia de productos y cocientes	<u>(95,950)</u>		<input checked="" type="checkbox"/>	60,000•00 +
Somma e differenza di prodotti e quozienti			1200 <input checked="" type="checkbox"/>	1,200• x
			30 <input type="checkbox"/>	30• =
			<input checked="" type="checkbox"/>	36,000•00 *
			1000 <input checked="" type="checkbox"/>	36,000•00 +
			20 <input type="checkbox"/>	1,000• ÷
				20• =
			<input checked="" type="checkbox"/>	50•00 *
				50•00 -
			<input checked="" type="checkbox"/>	95,950•00 *

Multiplication by a Constant	$300 \times 2,145 = (643,500)$		300 <input checked="" type="checkbox"/>	300• x
Multiplication mit einer Konstanten	$300 \times 4,950.6 = (1,484,180)$		2145 <input type="checkbox"/>	2,145• =
Multiplications à facteur constant	$300 \times 3,784.38 = (1,135,314)$			643,500•00 *
Multiplicación por una constante			4950.6 <input type="checkbox"/>	4,950•6 =
Moltiplicazioni con costante				1,485,180•00 *
			3784.38 <input type="checkbox"/>	3,784•38 =
				1,135,314•00 *

Division by a Constant	$31,750 \div 500 = (63.5)$		31750 <input checked="" type="checkbox"/>	31,750• ÷
Division durch eine Konstante	$54,236 \div 500 = (108.47)$		500 <input type="checkbox"/>	500• =
Divisions à facteur constant				63•50 *
División por una constante			54236 <input type="checkbox"/>	54,236• =
Divisioni con costante				108•47 *
				876•12 =
			876.12 <input type="checkbox"/>	1•75 *

Raising to Power Potenzierung Elévation à une puissance Elevación a potencia Elevazione a potenza	$3^5 = (243)$	 	$3 \times$ $= (3^2)$ $= (3^3)$ $= (3^4)$ $= (3^5)$	$3 \cdot \times$ $3 \cdot =$ $9 \cdot 000 \cdot *$ $9 \cdot 000 =$ $27 \cdot 000 \cdot *$ $27 \cdot 000 =$ $81 \cdot 000 \cdot *$ $81 \cdot 000 =$ $243 \cdot 000 \cdot *$
Reciprocal Calculation Reziprokrechnung Calcul réciproque Cálculo recíproco Calcoli reciproci	$1) \frac{1}{8} = (0.125)$	 	$8 \div$ $=$ $=$ $=$	$8 \cdot \div$ $8 \cdot =$ $1 \cdot 000 \cdot *$ $1 \cdot 000 =$ $0 \cdot 125 \cdot *$
	$2) \frac{1}{1.98} = (2.020)$ $\frac{1}{1.98}$ 4	 	$1.98 \div$ $4 =$ $+$ $=$ $=$	$1 \cdot 98 \div$ $4 \cdot =$ $0 \cdot 495 \cdot *$ $0 \cdot 495 \div$ $0 \cdot 495 =$ $1 \cdot 000 \cdot *$ $1 \cdot 000 =$ $2 \cdot 020 \cdot *$
Percentage Calculation: 17% of 2,350. Prozentrechnung 17% von 2 350 Calcul de pourcentage 17% de 2 350 Cálculo de porcentaje 17% de 2 350 Calcoli della percentuale 17% di 2 350	$2,350 \times \frac{17}{100}$ $= (399.5)$	 	$2350 \times$ 17%	$2,350 \cdot \times$ $17 \cdot \%$ $399 \cdot 50 \cdot *$
To find what percent 456 is of 789. Wieviel Prozent ist 456 von 789? Rapport de 456 à 789, en pourcentage Para calcular qué porcentaje de 789 es 456 Per trovare quale percentuale 456 sia di 789	$\frac{456}{789} \times 100$ $= (57.79)$	 	$456 \div$ 789%	$456 \cdot \div$ $789 \cdot \%$ $57 \cdot 79 \cdot *$



Add-On Calculation To increase 2,000 by 12%. Zuschlagsrechnung Aufschlag von 12% auf 2 000 Majoration Majoration de 12% sur 2 000 Cálculo de incremento Incremento de 2 000 en un 12% Calcolo della maggiorazione Per aumentare 2 000 del 12%	$2,000 + \left(2,000 \times \frac{12}{100} \right) = (2,240)$		2000 <input checked="" type="checkbox"/> 12 <input checked="" type="checkbox"/>	2,000 • x 12 • % 240 • 00 * 2,240 • 00 +%
--	--	---	--	--













Discount Calculation To discount 2,000 by 12%. Abschlagsrechnung Rabatt von 12% auf 2 000 Rabais Remise de 12% sur 2 000 Cálculo de descuento Descuento de 2 000 en un 12% Calcolo dello sconto Per fare lo sconto del 12% su 2 000	$2,000 - \left(2,000 \times \frac{12}{100} \right) = (1,760)$		2000 <input checked="" type="checkbox"/> 12 <input checked="" type="checkbox"/>	2,000 • x 12 • % 240 • 00 * 1,760 • 00 -%
--	--	---	--	--

Constant Percent Calculation Prozentrechnung mit einer Konstanten Pourcentages divers avec facteur constant Cálculo de porcentaje con constante Calcolo della percentuale con costante	$300 \times 3\% = (9)$ $300 \times 4\% = (12)$		300 <input checked="" type="checkbox"/> 3 <input checked="" type="checkbox"/> 4 <input checked="" type="checkbox"/>	300 • x 3 • % 9 • 00 * 4 • % 12 • 00 *
--	---	---	---	--















Constant Add-On Calculation Aufschlagsrechnung mit einer Konstanten Majoration à facteur constant Cálculo de incremento con constante Calcolo della maggiorazione con costante	$123 + 123 \times 12\% = (137.76)$ $123 + 123 \times 15\% = (141.45)$		123 <input checked="" type="checkbox"/> 12 <input checked="" type="checkbox"/> 15 <input checked="" type="checkbox"/>	123 • x 12 • % 14 • 76 * 137 • 76 +% 15 • % 18 • 45 * 141 • 45 +%
--	--	---	---	---

Memory Calculation
Rechnungen mit dem Speicher
Calculs utilisant la mémoire
Cálculo utilizando la memoria
Calcoli con la memoria

Sum and Difference of Products	243 × 12 = (2,916)		243 <input checked="" type="checkbox"/>	243. x
Summe und Differenz von Produkten	576 × 25 = (14,400)		12 <input type="checkbox"/>	12. =
Somme et différence de produits	+) 387 × 45 = (17,415)			2,916.00 M+
Suma y diferencia de productos	(34,731)			
Somma e differenza di prodotti	-) 456 × 32 = (14,592)		576 <input checked="" type="checkbox"/>	576. x
	(20,139)		25 <input type="checkbox"/>	25. =
				14,400.00 M+
			387 <input checked="" type="checkbox"/>	387. x
			45 <input type="checkbox"/>	45. =
				17,415.00 M+
			456 <input checked="" type="checkbox"/>	456. x
			32 <input type="checkbox"/>	32. =
				14,592.00 M-
			<input type="checkbox"/>	20,139.00 M*

Respective Totals of Data In Groups Summierung von Datengruppen Totaux respectifs de deux colonnes de chiffres Totales respectivos de datos agrupados Totali rispettivi di dati in gruppo	Q'ty Menge Quantité Cantidad Quantità	Amount (\$) Preis (\$) Montant (\$) Valor (\$) Ammontare (\$)		23  3200  34  4300    41  1400  52  2500   	23.00 + 3,200.00 M+ 34.00 + 4,300.00 M+ 57.00 \diamond 7,500.00 M \diamond 41.00 + 1,400.00 M+ 52.00 + 2,500.00 M+ 150.00 * 11,400.00 M*
	23	3,200			
	34	4,300			
	(57)	(7,500)			
	41	1,400			
	52	2,500			
	(150)	(11,400)			

Calculation Using Non-Add Key
Rechnungen mit der Nichtrechenaste
Utilisation de la touche de référence
Cálculo utilizando la tecla de no suma
Calcoli col tasto di non-addizione



Printing of Dates Ausdruck des Datums Impression de dates Impresión de fechas Stampa dei dati	1984.9.14 1984.9.15 1984.9.16	1,860 1,420 2,380 2,200 (7,860) 4,552 3,660 (8,212) (16,072)		1984.9.14  1860  1420  1984.9.15  2380  2200    1984.9.16  4552  3660    	#1984.9.14..... 1,860. + 1,420. + #1984.9.15..... 2,380. + 2,200. + 7,860. * 7,860. M+ #1984.9.16..... 4,552. + 3,660. + 8,212. * 8,212. M+ 16,072. M*
	1984.9.14	1,860			
	1984.9.15	2,380			
		2,200			
		(7,860)			
	1984.9.16	4,552			
		3,660			
		(8,212)			
		(16,072)			



Item Count Function
Postenzählfunktion
Utilisation du compteur de postes
Función de contador de entradas
Funzione del conta addendi

Item Counting	1	1,860		1860		1,860.00	+
Postenzählung	2	1,420		1420		1,420.00	+
Comptage de postes	3	2,380		2380		2,380.00	+
Contador de entradas	4	2,200		2200		2,200.00	+
Conta addendi	(4)	(7,860)				004.....	
	5	4,552		4552		7,860.00	◇
	6	3,660		3660		4,552.00	+
	7	7,432		7432		3,660.00	+
	8	8,500		8500		7,432.00	+
	(8)	(32,004)				008.....	
						32,004.00	*









Memory Item Count Calculation	243	$\times 0.86 = (208.98)$		243		243.	X
Rechnung mit dem Speicherpostenzähler	576	$\times 0.78 = (449.28)$.86		0.86	=
Compteur de postes à mémoire	387	$\times 0.88 = (340.56)$				208.98	M+
Cálculo con recuento de entradas de la memoria	(3)	(998.82)					
Calcolo di conta addendi in memoria				576		576.	X
				.78		0.78	=
						449.28	M+
				387		387.	X
				.88		0.88	=
						340.56	M+
						003.....	
						998.82	M*

Applied Calculation
Praktische Anwendungen
Applications
Cálculos aplicados
Calcoli applicati

Composition Ratio Calculation Prozentuale Anteilsberechnung Calcul du taux de contribution Cálculo de razón compuesta Calcolo della composizione percentuale	<table border="1"> <tr><td>A</td><td>123</td><td>(8.99)</td></tr> <tr><td>B</td><td>456</td><td>(33.33)</td></tr> <tr><td>C</td><td>789</td><td>(57.68)</td></tr> <tr><td></td><td>(1,368)</td><td>(100.00)</td></tr> </table> <p> $A = \frac{123}{1,368} \times 100 = (8.99)$ $B = \frac{456}{1,368} \times 100 = (33.33)$ $C = \frac{789}{1,368} \times 100 = (57.68)$ </p>	A	123	(8.99)	B	456	(33.33)	C	789	(57.68)		(1,368)	(100.00)	 	<table border="1"> <tr><td>123</td><td>+</td><td>123.00</td><td>+</td></tr> <tr><td>456</td><td>+</td><td>456.00</td><td>+</td></tr> <tr><td>789</td><td>+</td><td>789.00</td><td>+</td></tr> <tr><td>123</td><td>÷</td><td>123.</td><td>÷</td></tr> <tr><td></td><td>*</td><td>1,368.00</td><td>*</td></tr> <tr><td></td><td>%</td><td>1,368.00</td><td>%</td></tr> <tr><td></td><td></td><td>8.99</td><td>*</td></tr> <tr><td></td><td>M+</td><td>8.99</td><td>M+</td></tr> <tr><td>456</td><td>%</td><td>456.</td><td>%</td></tr> <tr><td></td><td></td><td>33.33</td><td>*</td></tr> <tr><td></td><td>M+</td><td>33.33</td><td>M+</td></tr> <tr><td>789</td><td>%</td><td>789.</td><td>%</td></tr> <tr><td></td><td></td><td>57.68</td><td>*</td></tr> <tr><td></td><td>M+</td><td>57.68</td><td>M+</td></tr> <tr><td></td><td>M+</td><td>100.00</td><td>M+</td></tr> </table>	123	+	123.00	+	456	+	456.00	+	789	+	789.00	+	123	÷	123.	÷		*	1,368.00	*		%	1,368.00	%			8.99	*		M+	8.99	M+	456	%	456.	%			33.33	*		M+	33.33	M+	789	%	789.	%			57.68	*		M+	57.68	M+		M+	100.00	M+
A	123	(8.99)																																																																									
B	456	(33.33)																																																																									
C	789	(57.68)																																																																									
	(1,368)	(100.00)																																																																									
123	+	123.00	+																																																																								
456	+	456.00	+																																																																								
789	+	789.00	+																																																																								
123	÷	123.	÷																																																																								
	*	1,368.00	*																																																																								
	%	1,368.00	%																																																																								
		8.99	*																																																																								
	M+	8.99	M+																																																																								
456	%	456.	%																																																																								
		33.33	*																																																																								
	M+	33.33	M+																																																																								
789	%	789.	%																																																																								
		57.68	*																																																																								
	M+	57.68	M+																																																																								
	M+	100.00	M+																																																																								

<p>Proportional Allotment To allot a budget of \$1,548 to three branch offices according to their sales</p> <p>Proportionale Zuteilung Um ein Budget in Höhe von \$1 548 drei Zweigstellen gemäß ihren Umsätzen zuzuteilen</p> <p>Répartition proportionnelle Répartir un budget de \$1 548 entre trois succursales en fonction de leur chiffre de ventes</p> <p>Repartición proporcional Repartición de un presupuesto de \$1 548 entre tres sucursales de acuerdo a sus ventas</p> <p>Ripartizione proporzionale Per ripartire un bilancio di 1 548 dollari tra tre sezioni secondo le loro vendite</p>	<table border="1"> <thead> <tr> <th>Store Geschäft Succursale Tienda Magazzino</th> <th>Sales Umsatz C.A. Ventas Vendite</th> <th>Budget Budget Allocation Presupuesto Bilancia</th> </tr> </thead> <tbody> <tr><td>A</td><td>147</td><td>(294)</td></tr> <tr><td>B</td><td>258</td><td>(516)</td></tr> <tr><td>C</td><td>369</td><td>(738)</td></tr> <tr><td></td><td>(774)</td><td>1,548</td></tr> </tbody> </table>	Store Geschäft Succursale Tienda Magazzino	Sales Umsatz C.A. Ventas Vendite	Budget Budget Allocation Presupuesto Bilancia	A	147	(294)	B	258	(516)	C	369	(738)		(774)	1,548	 	<table border="1"> <tr><td>147</td><td>+</td><td>147.00</td><td>+</td></tr> <tr><td>258</td><td>+</td><td>258.00</td><td>+</td></tr> <tr><td>369</td><td>+</td><td>369.00</td><td>+</td></tr> <tr><td></td><td>*</td><td>774.00</td><td>*</td></tr> <tr><td></td><td>M+</td><td>774.00</td><td>M+</td></tr> <tr><td>1548</td><td>÷</td><td>1,548.</td><td>÷</td></tr> <tr><td></td><td>M+</td><td>774.00</td><td>M+</td></tr> <tr><td></td><td>x</td><td>774.00</td><td>x</td></tr> <tr><td>147</td><td>=</td><td>147.</td><td>=</td></tr> <tr><td></td><td></td><td>294.00</td><td>*</td></tr> <tr><td>258</td><td>=</td><td>258.</td><td>=</td></tr> <tr><td></td><td></td><td>516.00</td><td>*</td></tr> <tr><td>369</td><td>=</td><td>369.</td><td>=</td></tr> <tr><td></td><td></td><td>738.00</td><td>*</td></tr> </table>	147	+	147.00	+	258	+	258.00	+	369	+	369.00	+		*	774.00	*		M+	774.00	M+	1548	÷	1,548.	÷		M+	774.00	M+		x	774.00	x	147	=	147.	=			294.00	*	258	=	258.	=			516.00	*	369	=	369.	=			738.00	*
Store Geschäft Succursale Tienda Magazzino	Sales Umsatz C.A. Ventas Vendite	Budget Budget Allocation Presupuesto Bilancia																																																																								
A	147	(294)																																																																								
B	258	(516)																																																																								
C	369	(738)																																																																								
	(774)	1,548																																																																								
147	+	147.00	+																																																																							
258	+	258.00	+																																																																							
369	+	369.00	+																																																																							
	*	774.00	*																																																																							
	M+	774.00	M+																																																																							
1548	÷	1,548.	÷																																																																							
	M+	774.00	M+																																																																							
	x	774.00	x																																																																							
147	=	147.	=																																																																							
		294.00	*																																																																							
258	=	258.	=																																																																							
		516.00	*																																																																							
369	=	369.	=																																																																							
		738.00	*																																																																							

Calculation Examples for Effective Use of Display and Printouts
Rechenbeispiele für wirksame Verwendung von Anzeige und Ausdruck
Exemples de calcul pour un emploi efficace de l'affichage et de l'impression
Ejemplos de cálculos para la utilización efectiva del indicador e impresiones
Esempi di calcolo per l'uso funzionale del quadrante e della stampa

Example Beispiel Exemple Ejemplo Esempio			Setting Einstellung Réglage Ajuste Sistemazione	Operation Ausführung Exécution Operación Operazione	Display Anzeige Affichage Indicador Quadrante	Printout Ausdruck Impression Impresión Stampa																																												
Checkbook Balance Scheckbuchsaldó Solde de carnet de chèque Balance del libro talonario Bilancio del conti	<table border="1"> <thead> <tr> <th>Deposits Einzahlungen Dépôts Ingresos Depositi</th> <th>Checks Cashed Eingelöste Schecks Chèques encaissés Talones cobrados Assegni incassati</th> <th>Balance Balance Solde Balance Bilancia</th> </tr> </thead> <tbody> <tr> <td>\$500.00</td> <td>\$255.25</td> <td>\$244.75</td> </tr> <tr> <td></td> <td>133.79</td> <td>110.96</td> </tr> <tr> <td></td> <td>110.00</td> <td>0.96</td> </tr> <tr> <td>50.00</td> <td></td> <td>50.96</td> </tr> <tr> <td></td> <td>10.00</td> <td>40.96</td> </tr> <tr> <td></td> <td>10.00</td> <td>30.96</td> </tr> </tbody> </table>	Deposits Einzahlungen Dépôts Ingresos Depositi	Checks Cashed Eingelöste Schecks Chèques encaissés Talones cobrados Assegni incassati	Balance Balance Solde Balance Bilancia	\$500.00	\$255.25	\$244.75		133.79	110.96		110.00	0.96	50.00		50.96		10.00	40.96		10.00	30.96		50000  25525  13379  11000  5000  1000   	500.00 244.75 110.96 0.96 50.96 40.96 30.96 30.96	<table> <tr> <td></td> <td>500.00</td> <td>+</td> </tr> <tr> <td></td> <td>255.25</td> <td>-</td> </tr> <tr> <td></td> <td>133.79</td> <td>-</td> </tr> <tr> <td>Red</td> <td>110.00</td> <td>-</td> </tr> <tr> <td>Rot</td> <td>50.00</td> <td>+</td> </tr> <tr> <td>Rouge</td> <td>10.00</td> <td>-</td> </tr> <tr> <td>Rojo</td> <td>10.00</td> <td>-</td> </tr> <tr> <td>Rosso</td> <td>30.96</td> <td>*</td> </tr> </table>		500.00	+		255.25	-		133.79	-	Red	110.00	-	Rot	50.00	+	Rouge	10.00	-	Rojo	10.00	-	Rosso	30.96	*
Deposits Einzahlungen Dépôts Ingresos Depositi	Checks Cashed Eingelöste Schecks Chèques encaissés Talones cobrados Assegni incassati	Balance Balance Solde Balance Bilancia																																																
\$500.00	\$255.25	\$244.75																																																
	133.79	110.96																																																
	110.00	0.96																																																
50.00		50.96																																																
	10.00	40.96																																																
	10.00	30.96																																																
	500.00	+																																																
	255.25	-																																																
	133.79	-																																																
Red	110.00	-																																																
Rot	50.00	+																																																
Rouge	10.00	-																																																
Rojo	10.00	-																																																
Rosso	30.96	*																																																

Specifications**Usable temperature:**

0°C to 40°C (32°F to 104°F)

Dimensions:

105 mm (wide) × 200 mm (long) × 48 mm (high)

(4-1/18" × 7-7/8" × 1-7/8")

Weight: 360 g (12.7 oz)**Printing paper:**

Canon Roll Paper MP-57 or ordinary calculator roll paper

(Width: 57~58 mm (2-1/4")
(Max. Diameter: 80 mm (3-5/32"))**Ink roller:**

Canon Ink Roller CP-13

(Subject to change without notice)

Technische Date**Verwendbar bei Temperaturen:**

von 0°C bis 40°C (von 32°F bis 104°F)

Abmessungen:

105 mm (breit) × 200 mm (lang) × 48 mm (hoch)

Gewicht: 360 g**Druckpapier:**

Canon Papierrolle MP-57 oder gewöhnliches Rechenmaschinenpapier

(Breit: 57~58 mm
(Max. Durchmesser: 80 mm)**Farbroller:**

Canon Farbroll CP-13

(Änderungen vorbehalten)

Fiche technique**Température d'utilisation:**

de 0°C à 40°C (de 32°F à 104°F)

Dimensions:

105 mm (largeur) × 200 mm (longueur) × 48 mm (hauteur)

Poids: 360 g**Papier d'impression:**

Rouleaux de papier Canon MP-57 ou papier ordinaire pour calculatrice

(Largeur: 57~58 mm
(Diamètre maximal: 80 mm)**Rouleau encreur:**

Rouleau encreur Canon CP-13

(Sous réserve de modifications sans préavis)

Especificaciones**Temperatura de funcionamiento**

0°C a 40°C (32°F a 104°F)

Dimensiones:

105 mm (ancho) × 200 mm (largo) × 48 mm (alto)

Peso: 360 g**Papel de imprimir:**

Rollo de papel Canon MP-57 o papel ordinario para calculadora

(Ancho: 57~58 mm
(Diametro máximo: 80 mm)**Rodillo entintador:**

Rodillo entintador CP-13 de Canon

(Sujeto a cambios sin previo aviso)

Caratteristiche**Temperatura d'esercizio**

0°C fino a 40°C (32°F fino a 104°F)

Dimensioni:

105 mm (largh.) × 200 mm (lungh.) × 48 mm (alt.)

Peso: 360 g**Carta da stampa:**

Rotolo di carta Canon MP-57 o carta ordinaria per calcolatrice

(Larghezza: 57~58 mm
(Diametro massimo: 80 mm)**Rullo dell'inchiostro:**

Rullo dell'inchiostro Canon CP-13

(Salvo modifiche senza preavviso)

Canon CANON INC.

7-1, Nishi-shinjuku 2-chome, Shinjuku-ku, Tokyo 160, Japan
P.O. Box 5050, Shinjuku Dai-ichi Seimei Building, Tokyo 160, Japan

CANON U.S.A., INC.

HEAD OFFICE One Canon Plaza, Lake Success, N.Y. 11042, U.S.A.

CHICAGO 140 Industrial Drive, Elmhurst, Illinois 60126, U.S.A.

LOS ANGELES 123 Paularino Avenue East, Costa Mesa, California 92626, U.S.A.

ATLANTA 6380 Peachtree Industrial Blvd., Norcross, Georgia 30071, U.S.A.

DALLAS 2035 Royal Lane, Suite 290, Dallas, Texas 75229, U.S.A.

CANON CANADA INC.

HEAD OFFICE 6390 Dixie Road, Mississauga, Ontario, L5T 1P7, Canada

CALGARY 282B, 16th Street, N.E. Calgary, Alberta, T2E 7K7, Canada

CANON EUROPA N.V.

P.O. Box 7907, 1008 AC Amsterdam, The Netherlands

CANON FRANCE S.A.

DIVISION CALCUL 93154 Le Blanc Mesnil, Cedex, France

CANON RECHNER DEUTSCHLAND GmbH.

Fraunhoferstrasse 14, Postfach 8033, München-Martinsried, West Germany

CANON UK LTD.

Canon House Manor Road Wallington, Surrey SM6 0AJ England

CANON LATIN AMERICA, INC.

SALES DEPARTMENT P.O. Box 7022, Panama 5, Rep. of Panama

REPAIR SERVICE CENTER P.O. Box 2019, Colon Free Zone, Rep. of Panama

CANON HONG KONG TRADING CO., LTD.

Golden Bear Industrial Centre, 7th Floor, 66-82 Chal Wan Kok Street, Tsuen Wan, New Territories, Kowloon, Hong Kong

CANON AUSTRALIA PTY. LTD.

1 Hall Street, Hawthorn East, Victoria 3123, Australia